



**LEAVE YOUR MARK
ON THE WORLD
NOT YOUR FLOOR.**



MINIMIZER CUSTOM MOLDED FLOOR MATS
• **TESTED AND TORTURED™** •
DAILY BY TRUCKERS FOR TRUCKERS



MINIMIZER.COM | TESTED & TORTURED | 800.248.3855

MINIMIZER PRODUCTS:

CUSTOM MOLDED FLOOR MATS



ULTIMATE PROTECTION FROM IN-CAB CORROSION

Whether it is the mud off your boots or your morning coffee, Minimizer Custom Molded Floor Mats keep the cab floors of all major OEM makes and models protected from the daily abuses of demanding jobsites and endless miles on the road.

Engineers at Minimizer use cutting edge technology to scan interior measurements and angles of each specific make and model semi cab to ensure an exact fit. A retention hook is mounted to the base of the stick shift or the driver side floor to keep your floor mats in place. Protect your investment and reduce in cab corrosion, potentially saving you a major headache down the road.

HEAVY DUTY PROPRIETARY MATERIAL:

Textured with ribbed fluid channels to ensure a solid grip

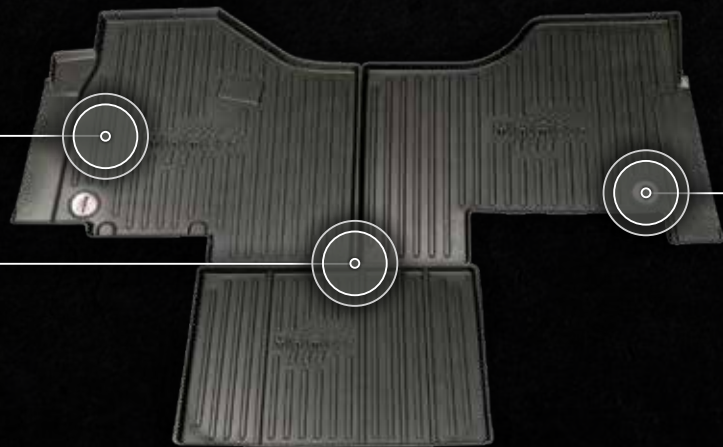

AVAILABLE IN 2 & 3 PIECE TRAY SYSTEMS:

Engineered for maximum coverage and quick removal

TOUGH, RUGGED, DURABLE:

Designed for hard work, daily abuse and extreme conditions

MANUFACTURING DISCLAIMER:

Minimizer custom molded floor mats are sold as aftermarket parts and are not FREIGHTLINER, WESTERN STAR, PETERBILT, KENWORTH, INTERNATIONAL, MACK, VOLVO, STERLING or CATERPILLAR goods.

FREIGHTLINER, WESTERN STAR, PETERBILT, KENWORTH, INTERNATIONAL, MACK, VOLVO, STERLING AND CATERPILLAR are all federally registered marks of their respective parent companies.



FREIGHTLINER: Part #10002211 (FKFRTLASCAB)

- Cascadia 113 Equipped with DD13 Engine and Manual Transmission 2008-2020
- Cascadia Evolution 113 with DD13 Engine and Manual Transmission 2014-2020
- Cascadia 113 with Automatic Transmission 2008-2020
- Cascadia Evolution 113 with Automatic Transmission 2014-2020
- Cascadia 125 with Automatic Transmission 2008-2020
- Cascadia Evolution 125 with Automatic Transmission 2020

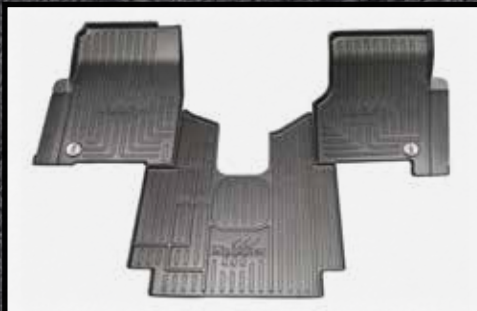

FREIGHTLINER: Part #10002231 (FKFRTLASCMB)

- Cascadia 113 with DD15 or Cummins Engine and Manual Transmission 2008-2020
- Cascadia 125 with Manual Transmission 2008-2020
- Cascadia Evolution 125 with Manual Transmission 2014-2020



FREIGHTLINER: Part #10002331 (103738) - MANUAL

- New Cascadia 126 2018 - 2022
- New Cascadia 116 2018 - 2022
- Western Star 49X 2021 - 2022

*Driver, passenger, and center floor mats are designed to fit the most common OEM seat bases. In some cases hand trimming along raised ribs is required

*Hand trimming of the passenger mat and center mat is required when installing in trucks equipped with battery box passenger seat.

*Floor mat kits are compatible both with day cab and sleeper cab configurations.



FREIGHTLINER: Part #10002323 (103739) - AUTOMATIC

- New Cascadia 126 2018-2022
- New Cascadia 116 2018-2022
- Western Star 49X 2021-2022

*Driver, passenger, and center floor mats are designed to fit the most common OEM seat bases. In some cases hand trimming along raised ribs is required

*Hand trimming of the passenger mat and center mat is required when installing in trucks equipped with battery box passenger seat.

*Floor mat kits are compatible both with day cab and sleeper cab configurations.



FREIGHTLINER: Part #10002247 (FKFRTL1B)

- Freightliner M2 106 2003-2022*
- Freightliner M2 112 2003-2022*
- Freightliner 108SD 2013-2022*
- Freightliner 114SD 2013-2022*

*Compatible with truck models equipped with a full width bench seat OR a National brand driver seat with air suspension base.



FREIGHTLINER: Part #10002265 (FKFRTL2B)

- Freightliner M2 106 2003-2022*
- Freightliner M2 112 2003-2022*
- Freightliner 108SD 2013-2022*
- Freightliner 114SD 2013-2022*

*Compatible with trucks equipped with any driver seat except a full width bench or National brand driver seat with air suspension base.



FREIGHTLINER: Part #10002290 (FKFRTL3MB) - MANUAL

- Columbia (CL112, CL120) 1999-2010
- Columbia Glider Kits (CL112, CL120) 2011-2020
- Century Class S/T (CST112, CST120) 1997-2010
- Coronado (CC114, CC122, CC132) 2002-2009
- Coronado Glider Kits (CC114, CC122, CC132) 2010-2021*

*Compatibility with Coronado glider kit trucks is dependent on interior type.
- Kit #100864 and #100865 are compatible with Coronado glider kit trucks equipped with a second generation interior.
- For Coronado glider kits with first generation interior use kit 10002290 or 10002277.



FREIGHTLINER: Part #10002277 (FKFRTL3AB) - AUTOMATIC

- Columbia (CL112, CL120) 1999-2010
- Columbia Glider Kits (CL112, CL120) 2011-2020
- Century Class S/T (CST112, CST120) 1997-2010
- Coronado (CC114, CC122, CC132) 2002-2009
- Coronado Glider Kits (CC114, CC122, CC132) 2010-2021*

*Compatibility with Coronado glider kit trucks is dependent on interior type.
- Kit #100864 and #100865 are compatible with Coronado glider kit trucks equipped with a second generation interior.
- For Coronado glider kits with first generation interior use kit 10002290 or 10002277.



FREIGHTLINER: Part #10002311 (100864) - MANUAL

- Coronado CC122 2010-2016*
- Coronado CC132 2010-2016*
- 122SD 2013-2022*

*Compatibility with Coronado glider kit trucks is dependent on interior type.
- Kit #100864 and #100865 are compatible with Coronado glider kit trucks equipped with a second generation interior.
- For Coronado glider kits with first generation interior use kit 10002290 or 10002277.



FREIGHTLINER: Part #10002300 (100865) - AUTOMATIC

- Coronado CC122 2010-2016*
- Coronado CC132 2010-2016*
- 122SD 2013-2022*

*Compatibility with Coronado glider kit trucks is dependent on interior type.
- Kit #100864 and #100865 are compatible with Coronado glider kit trucks equipped with a second generation interior.
- For Coronado glider kits with first generation interior use kit 10002290 or 10002277.



INTERNATIONAL: Part #10002358 (FKINTL1MB)

- ProStar - Manual 2011-2017
- LoneStar - Manual 2011-2022
- LT 625 - Manual 2018-2022
- RH613 - Manual 2018-2022
- International HX 515 2022*
- International HX 615 2022*
- International HX 520 2022*
- International HX 620 2022*

*Passenger floor mat is not compatible with battery box seat base
*Controls mounted between the seats may interfere with the fit of the center floor mat.



INTERNATIONAL: Part #10002342 (FKINTL1AB)

- ProStar - Automatic 2011-2017
- LoneStar - Automatic 2011-2022
- LT 625 - Automatic 2018-2022
- RH613 - Automatic 2018-2022
- International HX 515 2022*
- International HX 615 2022*
- International HX 520 2022*
- International HX 620 2022*

*Passenger floor mat is not compatible with battery box seat base

*Contols mounted between the seats may interfere with the fit of the center floor mat.



INTERNATIONAL: Part #10002412 (FKINTL2B)

- 4100, 4200, 4300, 4400 2002-2007
- WorkStar 7300, 7400, 7500 2008-2019
- DuraStar 4100, 4300, 4400 2008-2019*
- MV60H 2019-2022*
- HV607 2019-2022
- 7300, 7400, 7500, 8500 2002-2007
- TranStar 8500 2008-2019
- MV607 2019-2022*
- HV507 2019-2022

* Model year 2016 thru 2020 International MV607, MV60H, DuraStar 4300, and DuraStar 4400 trucks that are equipped with the Cummins ISB 6.7L engine together with the Allison RDS transmission are not compatible with the passenger side floor mat. Driver side floor mats are compatible with all engine and transmission configurations.

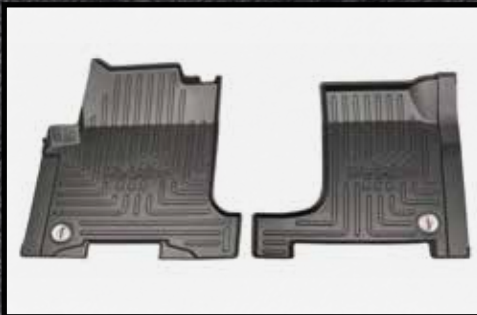

INTERNATIONAL: Part #10002433 (FKINTL3B)

- HV513 2019-2022
- WorkStar 7600 2008-2019
- 7600 2002-2007
- TranStar 8600 2008-2019
- HV613 2019-2022
- WorkStar 7700 2008-2019
- 7700 2005-2007
- 8600 2002-2007



INTERNATIONAL: Part #10002442 (103254) - MANUAL

- 9100i 2000-2003
- 5500i, 5600i, 5900i, 9200i, 9400i, 9900i 2000-2011 (Premium Interior Package Only)

*Manual gearshift location 10" - 11" behind dog house.



INTERNATIONAL: Part #10002447 (103255) - MANUAL

- 9100i 2000-2003
- 5500i, 5600i, 5900i, 9200i, 9400i, 9900i 2000-2011 (Premium Interior Package Only)

*Manual gearshift location 6" - 7" behind dog house.



INTERNATIONAL: Part #10002451 (103256) - MANUAL

- 9100i 2000-2003
- 5500i, 5600i, 5900i, 9200i, 9400i, 9900i 2000-2011 (Premium Interior Package Only)

*Manual gearshift location 13" - 14" behind dog house.



INTERNATIONAL: Part #10002456 (103257) - AUTOMATIC

- 5500i, 5600i, 5900i, 9200i, 9400i, 9900i 2000-2011

*Auto transmission Premium interior package.



INTERNATIONAL: Part #10002460 (103258) - MANUAL

- 5500i, 5600i, 5900i, 9200i, 9400i, 9900i 2000-2011

*Manual gearshift location 10" - 11" behind dog house.

**Eagle interior package.



INTERNATIONAL: Part #10002464 (103259) - MANUAL

- 5500i, 5600i, 5900i, 9200i, 9400i, 9900i 2000-2011

*Manual gearshift location 6" - 7" behind dog house.

**Eagle interior package.



INTERNATIONAL: Part #10002372 (103260) - MANUAL

- 5500i, 5600i, 5900i, 9200i, 9400i, 9900i 2000-2011

*Manual gearshift location 13" - 14" behind dog house.

**Eagle interior package.



INTERNATIONAL: Part #10002377 (103261) - AUTOMATIC

- 5500i, 5600i, 5900i, 9200i, 9400i, 9900i 2000-2011

* Auto transmission Eagle interior package.



INTERNATIONAL: Part #10002381 (103262) - MANUAL

- 5900i SBA 2013-2017
- 9900i 2013-2018

* Manual transmission Eagle interior package.



INTERNATIONAL: Part #10002386 (103263) - AUTOMATIC

- 5900i SBA 2013-2017
- 9900i 2013-2018

*Automatic transmission with Eagle interior package.

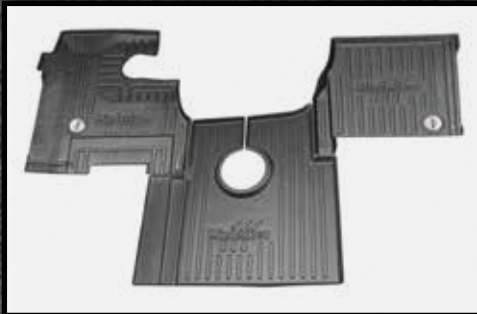

INTERNATIONAL: Part #10002390 (103264) - MANUAL

- 5900i SBA 2013-2017
- 9900i 2013-2018

*Manual transmission with Premium interior package.



INTERNATIONAL: Part #10002394 (103265) - AUTOMATIC

- 5900i SBA 2013-2017
- 9900i 2013-2018

*Automatic transmission with Premium interior package.

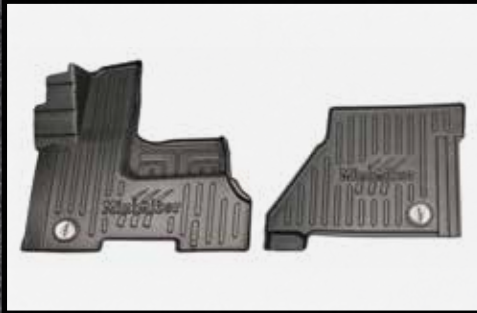

INTERNATIONAL/CATERPILLAR: Part #10002399 (103556)

- International HX515 2017-2021
- International HX615 2017-2021
- International HX520 2017-2021
- International HX620 2017-2021
- CAT CT660 2012-2017
- CAT CT680 2014-2017
- CAT CT681 2014-2017

*Note: Trucks equipped with a passenger side cup holder unit are not compatible with the Minimizer passenger side floor mat.



KENWORTH: Part #10002484 (100888) - MANUAL

- T440 2011-2022
- T600 2006-2007
- T800 2006-2022
- T470 2011-2022
- T660 2007-2017
- W900 2006-2022

*For sleeper cab trucks and extended day cab trucks equipped with a manual transmission.

**Year 2006 trucks with the throttle pedal mounted to the floor are not compatible.



KENWORTH: Part #10002508 (100889) - MANUAL

- T440 2011-2022
- T600 2006-2007
- T800 2006-2022
- T470 2011-2022
- T660 2007-2017
- W900 2006-2022

*For standard day cab trucks equipped with a manual transmission.

**Year 2006 trucks with the throttle pedal mounted to the floor are not compatible.



KENWORTH: Part #10002526 (100890) - AUTOMATIC

- T440 2011-2022
- T600 2006-2007
- T800 2006-2022
- T470 2011-2022
- T660 2007-2017
- W900 2006-2022

*For sleeper cab trucks and extended day cab trucks equipped with an automatic transmission.
 **Year 2006 trucks with the throttle pedal mounted to the floor are not compatible.

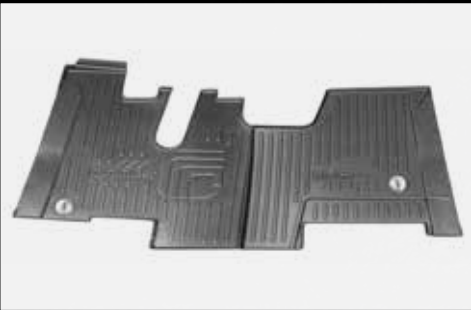

KENWORTH: Part #10002539 (100891) - AUTOMATIC

- T440 2011-2022
- T600 2006-2007
- T800 2006-2022
- T470 2011-2022
- T660 2007-2017
- W900 2006-2022

*For standard day cab trucks equipped with an automatic transmission.
 **Year 2006 trucks with the throttle pedal mounted to the floor are not compatible.



KENWORTH: Part #10002547 (105187) - AUTOMATIC

- T270 2006-2022*
- T370 2006-2022*
- T300 2002-2006*

*Automatic Transmission with passenger seat storage box (Battery box trim line option)
 **Must have the plastic trim around steering column



KENWORTH: Part #10002549 (105188) - AUTOMATIC

- T270 2006-2022*
- T370 2006-2022*
- T300 2002-2006*

*Automatic Transmission with passenger bench seat (Passenger air ride seat trim line option)
 **Must have the plastic trim around steering column

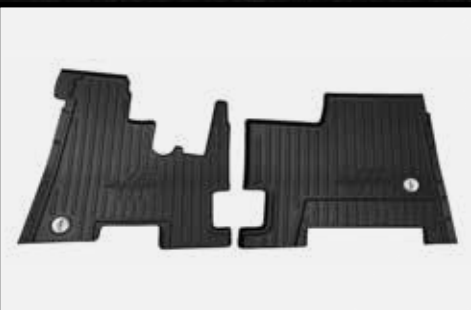

KENWORTH: Part #10002551 (105189) - MANUAL

- T270 2006-2022*
- T370 2006-2022*
- T300 2002-2006*

*Manual Transmission with passenger seat storage box (Battery box trim line option)
 **Must have the plastic trim around steering column

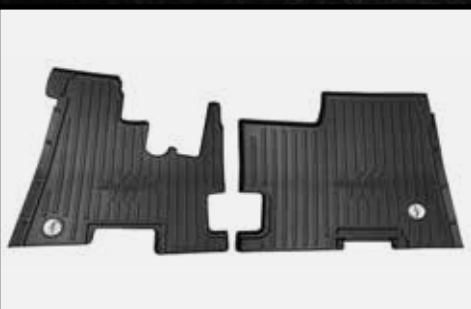

KENWORTH: Part #10002470 (105190) - MANUAL

- T270 2006-2022*
- T370 2006-2022*
- T300 2002-2006*

*Manual Transmission with passenger bench seat (Passenger air ride seat trim line option)
 **Must have the plastic trim around steering column

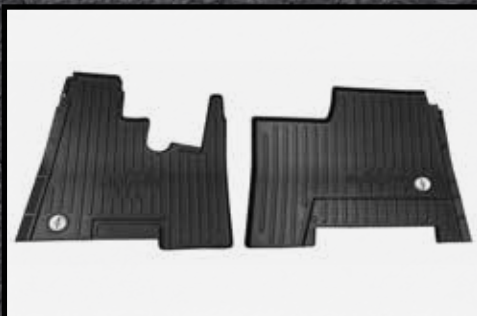

KENWORTH: Part #10002471 (105191) - AUTOMATIC

- T600 2002-2006*
- T800 2002-2006*
- W900 2002-2006*

*Automatic Transmission with passenger seat storage box (Battery box trim line option)
 **Must have the plastic trim around steering column
 ***2006 models must have the floor mounted throttle pedal



KENWORTH: Part #10002472 (105192) - AUTOMATIC

- T600 2002-2006*
- T800 2002-2006*
- W900 2002-2006*

*Automatic Transmission with passenger bench seat (Passenger air ride seat trim line option)
 **Must have the plastic trim around steering column
 ***2006 models must have the floor mounted throttle pedal



KENWORTH: Part #10002473 (105193) - MANUAL

- T600 2002-2006*
- T800 2002-2006*
- W900 2002-2006*

*Manual Transmission with passenger seat storage box (Battery box trim line option)
 **Must have the plastic trim around steering column
 ***2006 models must have the floor mounted throttle pedal



KENWORTH: Part #1 0002475 (105194) - MANUAL

- T600 2002-2006*
- T800 2002-2006*
- W900 2002-2006*

*Manual Transmission with passenger bench seat (Passenger air ride seat trim line option)
 **Must have the plastic trim around steering column
 ***2006 models must have the floor mounted throttle pedal



KENWORTH: Part #10005579 - MANUAL

- Kenworth T680 2013-2023
- Kenworth T880 2014-2023

Manual transmission with GRA-MAG air-ride driver and passenger seats or GRA-MAG air-ride driver seat with tube steel static passenger seat (Trim Option).



KENWORTH: Part #10005580 - AUTOMATIC

- Kenworth T680 2013-2023
- Kenworth T880 2014-2023
- Kenworth W990 2019-2023

Automatic transmission with GRA-MAG air-ride driver and passenger seats or GRA-MAG air-ride driver seat with tube steel static passenger seat (Trim Option).



KENWORTH: Part #10005581 - MANUAL

- Kenworth W990 2019-2023

Manual transmission with GRA-MAG air-ride driver and passenger seats or GRA-MAG air-ride driver seat with tube steel static passenger seat (Trim Option).



KENWORTH: Part #10005585 - MANUAL

- Kenworth T680 2013-2023
- Kenworth T880 2014-2023

Manual transmission with GRA-MAG air-ride driver seat and storage box static passenger seat or GRA-MAG air-ride driver seat with battery box static passenger seat (Trim Option).



KENWORTH: Part #10005586 - AUTOMATIC

- Kenworth T680 2013-2023
- Kenworth T880 2014-2023
- Kenworth W990 2019-2023

Automatic transmission with GRA-MAG air-ride driver seat and storage box static passenger seat or GRA-MAG air-ride driver seat with battery box static passenger seat (Trim Option).



KENWORTH: Part #10005587 - MANUAL

- Kenworth W990 2019-2023

Manual transmission with GRA-MAG air-ride driver seat and storage box static passenger seat or GRA-MAG air-ride driver seat with battery box static passenger seat (Trim Option).



KENWORTH: Part #10005588 - AUTOMATIC

- Kenworth T680 2013-2023
- Kenworth T880 2014-2023
- Kenworth W990 2019-2023

Automatic transmission with Sears air-ride driver seat and GRA-MAG air-ride passenger seat or Sears air-ride driver seat with tube steel static passenger seat (Trim Option).



KENWORTH: Part #10005590 - AUTOMATIC

- Kenworth T680 2013-2023
- Kenworth T880 2014-2023
- Kenworth W990 2019-2023

Automatic transmission with Sears air-ride driver seat and storage box static passenger seat or Sears air-ride driver seat with battery box static passenger seat (Trim Option).



KENWORTH: Part #1000591 - MANUAL

- Kenworth T680 2013-2023
- Kenworth T880 2014-2023

Manual transmission with Sears air-ride driver seat and GRA-MAG air-ride passenger seat or Sears air-ride driver seat with tube steel static passenger seat (Trim Option).



KENWORTH: Part #1000593 - MANUAL

- Kenworth T680 2013-2023
- Kenworth T880 2014-2023

Manual transmission with Sears air-ride driver seat and storage box static passenger seat or Sears air-ride driver seat with battery box static passenger seat (Trim Option).



KENWORTH: Part #1000594 - MANUAL

- Kenworth W990 2019-2023

Manual transmission with Sears air-ride driver seat and GRA-MAG air-ride passenger seat or Sears air-ride driver seat with tube steel static passenger seat (Trim Option).



KENWORTH: Part #1000596 - MANUAL

- Kenworth W990 2019-2023

Manual transmission with Sears air-ride driver seat and storage box static passenger seat or Sears air-ride driver seat with battery box static passenger seat (Trim Option).



KENWORTH: Part #10006164 - AUTOMATIC

- Kenworth T680 2013-2023
- Kenworth T880 2014-2023
- Kenworth W990 2019-2023

Automatic transmission with GRA-MAG air-ride driver seat and Sears air-ride passenger seat.



KENWORTH: Part #10006165 - AUTOMATIC

- Kenworth T680 2013-2023
- Kenworth T880 2014-2023
- Kenworth W990 2019-2023

Automatic transmission with Sears air-ride driver seat and Sears air-ride passenger seat.



KENWORTH: Part #10006166 - MANUAL

- Kenworth W990 2019-2023

Manual transmission with GRA-MAG air-ride driver seat and Sears air-ride passenger seat.



KENWORTH: Part #10006167 - MANUAL

- Kenworth T680 2013-2023
- Kenworth T880 2014-2023

Manual transmission with GRA-MAG air-ride driver seat and Sears air-ride passenger seat.



KENWORTH: Part #10006168 - MANUAL

- Kenworth W990 2019-2023

Manual transmission with Sears air-ride driver seat and Sears air-ride passenger seat.



KENWORTH: Part #10006169 - MANUAL

- Kenworth T680 2013-2023
- Kenworth T880 2014-2023

Manual transmission with Sears air-ride driver seat and storage box static passenger seat or Sears air-ride driver seat with battery box static passenger seat (Trim Option).



MACK: Part #10002556 (FKMACK1B)

- Mack Granite 2007 - 2012
- Mack Pinnacle 2007 - 2012

- | | | | | |
|----------|----------|----------|----------|----------|
| • CT713 | • CU713 | • GU432 | • GU433 | • GU532 |
| • GU533 | • GU712 | • GU713 | • GU714 | • GU813 |
| • CHU603 | • CHU612 | • CHU613 | • CHU614 | • CXP613 |
| • CXU612 | • CXU613 | • CXU614 | • CHN613 | |



MACK: Part #10002582 (FKMACK2B)

- Mack Granite 2013-2022
- Mack Pinnacle 2013-2022
- Mack Anthem 2018-2022

- | | | | | |
|----------|----------|----------|----------|----------|
| • CT713 | • CU713 | • GU432 | • GU433 | • GU532 |
| • GU533 | • GU712 | • GU713 | • GU714 | • GU813 |
| • CHU603 | • CHU612 | • CHU613 | • CHU614 | • CXP613 |
| • CXU612 | • CXU613 | • CXU614 | • CHN613 | |



PETERBILT: Part #10002663 (FKPB2B) - MANUAL

- 365 2008-2022*
- 384 2008-2017*
- 388 2008-2017*
- 367 2008-2022*
- 386 2006-2017*
- 389 2008-2022*

*Note – If the distance from the driver's seat base to the dashboard kick panel is 27", use part #10002663. If that distance is 28.75" use part #10002675. If the truck has an automatic transmission with floor mounted control tower, see part #10002688. If the truck has an automatic transmission with controls on the dash or seat see kits #10002722 & #10002728. Passenger side mat does not fit models with battery box under passenger seat.



PETERBILT: Part #10002675 (FKPB3B) - MANUAL

- 365 2008-2022*
- 384 2008-2017*
- 388 2008-2017*
- 367 2008-2022*
- 386 2006-2017*
- 389 2008-2022*

*Note – If the distance from the driver's seat base to the dashboard kick panel is 27", use part #10002663. If that distance is 28.75" use part #10002675. If the truck has an automatic transmission with floor mounted control tower, see part #10002688. If the truck has an automatic transmission with controls on the dash or seat see kits #10002722 & #10002728. Passenger side mat does not fit models with battery box under passenger seat.



PETERBILT: Part #10002688 (FKPB4B) - MANUAL

- 378 2006-2007
- 385 2006-2007
- 365 2006-2022*
- 384 2006-2017*
- 388 2006-2017*
- 379 2006-2007
- 357 2006-2007
- 367 2006-2022*
- 386 2006-2017*
- 389 2006-2022*

*For trucks equipped with an automatic transmission with a control tower mounted to the floor. Passenger side mat does not fit models with battery box under passenger seat.



PETERBILT: Part #10002722 (104104) - AUTOMATIC

- 365 2008-2022*
- 384 2008-2017*
- 388 2008-2017*
- 367 2008-2022*
- 386 2006-2017*
- 389 2008-2022*

*Note--If the truck has an automatic transmission with controls on the dash or on the seat, and the distance from the driver seat to the dashboard kick panel is 27", use part # 10002722. If the truck has an automatic transmission with a control tower mounted to the floor, see part #10002688. Passenger side mat does not fit models with battery box under passenger seat.



PETERBILT: Part #10002728 (104105) - AUTOMATIC

- 365 2008-2022*
- 384 2008-2017*
- 388 2008-2017*
- 367 2008-2022*
- 386 2006-2017*
- 389 2008-2022*

*Note-- If the truck has an automatic transmission with controls on the dash or the seat, and the distance from the driver seat to the dashboard kick panel is 28.75", use part # 10002728. If the truck has an automatic transmission with a control tower mounted to the floor, see part #10002688. Passenger side mat does not fit models with battery box under passenger seat.



PETERBILT: Part #10002702 (FKPB5B)

- 357 5/2004 - model year 2005
- 378 5/2004 - model year 2005
- 379 5/2004 - model year 2005
- 385 5/2004 - model year 2005



PETERBILT: Part #10002712 (FKPB6B)

- 357 All dates prior to 5/2004
- 377 All dates prior to 5/2004
- 378 All dates prior to 5/2004
- 379 All dates prior to 5/2004
- 385 All dates prior to 5/2004



PETERBILT: Part #10002732 (105036) - AUTOMATIC

- 337 2010-2022*
- 348 2010-2022*

* Fits passenger seat located 29" from the dash with storage compartment.
 - Raised trim lines for the storage compartment seat base when located 27.25" from dash.
 - Raised trim lines for fit of aftermarket passenger seats and the Minimizer Long Haul Series seat.



PETERBILT: Part #10002650 (105037) - MANUAL

- 337 2010-2022*
- 348 2010-2022*

* Fits passenger seat located 29" from the dash with storage compartment.
 - Raised trim lines for specific gearshift position.
 - Raised trim lines for the storage compartment seat base when located 27.25" from dash.
 - Raised trim lines for fit of aftermarket passenger seats and the Minimizer Long Haul Series seat.



PETERBILT: Part #10002652 (105038) - AUTOMATIC

- 337 2010-2022*
- 348 2010-2022*

* Passenger side mat fits two-man bench seat.
 - Raised trim lines for passenger seat with battery box seat base.



PETERBILT: Part #10002655 (105039) - MANUAL

- 337 2010-2022*
- 348 2010-2022*

* Passenger side mat fits two-man bench seat.
 - Raised trim lines for specific gearshift position.
 - Raised trim lines for passenger seat with battery box seat base.



PETERBILT: Part #10005579 - MANUAL

- Peterbilt 567 2014-2023
- Peterbilt 579 2013-2023

Manual transmission with GRA-MAG air-ride driver and passenger seats or GRA-MAG air-ride driver seat with tube steel static passenger seat (Trim Option).



PETERBILT: Part #10005580 - AUTOMATIC

- Peterbilt 567 2014-2023
- Peterbilt 579 2013-2023

Automatic transmission with GRA-MAG air-ride driver and passenger seats or GRA-MAG air-ride driver seat with tube steel static passenger seat (Trim Option).



PETERBILT: Part #10005585 - MANUAL

- Peterbilt 567 2014-2023
- Peterbilt 579 2013-2023

Manual transmission with GRA-MAG air-ride driver seat and storage box static passenger seat or GRA-MAG air-ride driver seat with battery box static passenger seat (Trim Option).



PETERBILT: Part #10005586 - AUTOMATIC

- Peterbilt 567 2014-2023
- Peterbilt 579 2013-2023

Automatic transmission with GRA-MAG air-ride driver seat and storage box static passenger seat or GRA-MAG air-ride driver seat with battery box static passenger seat (Trim Option).



PETERBILT: Part #10005588 - AUTOMATIC

- Peterbilt 567 2014-2023
- Peterbilt 579 2013-2023

Automatic transmission with Sears air-ride driver seat and GRA-MAG air-ride passenger seat or Sears air-ride driver seat with tube steel static passenger seat (Trim Option).



PETERBILT: Part #10005590 - AUTOMATIC

- Peterbilt 567 2014-2023
- Peterbilt 579 2013-2023

Automatic transmission with Sears air-ride driver seat and storage box static passenger seat or Sears air-ride driver seat with battery box static passenger seat (Trim Option).



PETERBILT: Part #10005591 - MANUAL

- Peterbilt 567 2014-2023
- Peterbilt 579 2013-2023

Manual transmission with Sears air-ride driver seat and GRA-MAG air-ride passenger seat or Sears air-ride driver seat with tube steel static passenger seat (Trim Option).



PETERBILT: Part #10005593 - MANUAL

- Peterbilt 567 2014-2023
- Peterbilt 579 2013-2023

Manual transmission with Sears air-ride driver seat and storage box static passenger seat or Sears air-ride driver seat with battery box static passenger seat (Trim Option).



PETERBILT: Part #10006164 - AUTOMATIC

- Peterbilt 567 2014-2023
- Peterbilt 579 2013-2023

Automatic transmission with GRA-MAG air-ride driver seat and Sears air-ride passenger seat.



PETERBILT: Part #10006165 - AUTOMATIC

- Peterbilt 567 2014-2023
- Peterbilt 579 2013-2023

Automatic transmission with Sears air-ride driver seat and Sears air-ride passenger seat.



PETERBILT: Part #10006167 - MANUAL

- Peterbilt 567 2014-2023
- Peterbilt 579 2013-2023

Manual transmission with GRA-MAG air-ride driver seat and Sears air-ride passenger seat.



PETERBILT: Part #10006169 - MANUAL

- Kenworth T680 2013-2023
- Kenworth T880 2014-2023

Manual transmission with Sears air-ride driver seat and storage box static passenger seat or Sears air-ride driver seat with battery box static passenger seat (Trim Option).

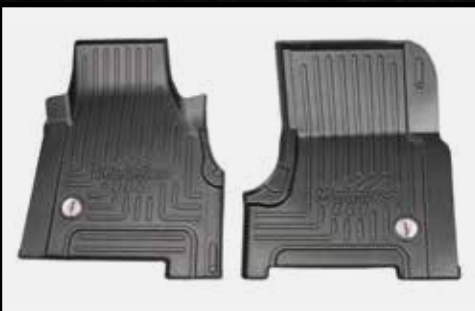

STERLING: Part #10002736 (FKST1B)

- AT Series (9500, 9513, 9522) 1996-2010*
- LT Series (7500, 7501, 8500, 8501, 8511, 8513, 9000, 9501, 9511, 9513, 9522) 1996-2010*
- A Series (9500, 9513) 1996-2010*
- L Series (7500, 7501, 8500, 8501, 8511, 8513, 9000, 9501, 9500, 9511, 9513, 9522) 1996-2010*
- Acterra Series (5500, 6500, 7500, 8500) 1999-2010*

*Compatible with 1996-2009 Sterling/Ford Models with suspended throttle and brake pedals.



STERLING: Part #10002743 (FKST2B)

- AT Series (9500, 9513, 9522) **1996-2010***
- LT Series (7500, 7501, 8500, 8501, 8511, 8513, 9000, 9501, 9511, 9513, 9522) **1996-2010***
- A Series (9500, 9513) **1996-2010***
- L Series (7500, 7501, 8500, 8501, 8511, 8513, 9000, 9501, 9500, 9511, 9513, 9522) **1996-2010***
- Acterra Series (5500, 6500, 7500, 8500) **1999-2010***

*Compatible with 1996-2009 Sterling/Ford Models with a suspended throttle pedal and a floor mounted brake pedal.

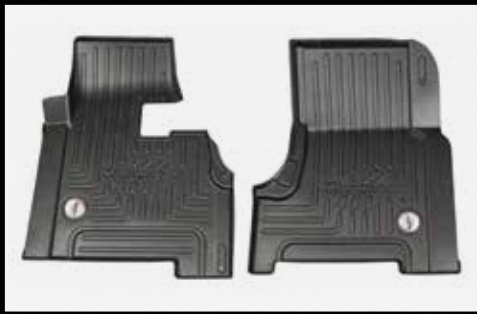

STERLING: Part #10002751 (FKST3B)

- AT Series (9500, 9513, 9522) **1996-2010***
- LT Series (7500, 7501, 8500, 8501, 8511, 8513, 9000, 9501, 9511, 9513, 9522) **1996-2010***
- A Series (9500, 9513) **1996-2010***
- L Series (7500, 7501, 8500, 8501, 8511, 8513, 9000, 9501, 9500, 9511, 9513, 9522) **1996-2010***
- Acterra Series (5500, 6500, 7500, 8500) **1999-2010***

*Compatible with 1996-2009 Sterling/Ford Models with floor mounted throttle pedal and floor mounted brake pedal.



VOLVO: Part #10002761 (FKVOLVO1AB) - AUTOMATIC

- VNL300 **2004-2018**
- VNL630 **2004-2018**
- VNL730 **2004-2018**
- VT Models **2006-2010**
- VNL430 **2004-2018**
- VNL670 **2004-2018**
- VNL780 **2004-2018**



VOLVO: Part #10002778 (FKVOLVO1MB) - MANUAL

- VNL300 **2004-2018**
- VNL630 **2004-2018**
- VNL730 **2004-2018**
- VT Models **2006-2010**
- VNL430 **2004-2018**
- VNL670 **2004-2018**
- VNL780 **2004-2018**



VOLVO: Part #10002792 (104245)

- Volvo VNR **2018-2022**
- Volvo VHD **2019-2022**
- Volvo VAH **2019-2022**
- Volvo VNL **2019-2022**
- Volvo VNX **2019-2022**

Use this kit for trucks with an air ride passenger seat.

Hand trimming is required for any truck equipped with a manual transmission or a Allison RDS automatic transmission.



VOLVO: Part #10002798 (104246)

- Volvo VNR **2018-2022**
- Volvo VHD **2019-2022**
- Volvo VAH **2019-2022**
- Volvo VNL **2019-2022**
- Volvo VNX **2019-2022**

Use this kit for trucks equipped with a static passenger seat or two man bench seat.

Hand trimming is required for any truck equipped with a manual transmission or a Allison RDS automatic transmission.



WESTERN STAR: Part #10002807 (FKSTAR1B)

- 4900EX 1998-2016*

* 2016 trucks with throttle pedal mounted to the fire wall are not compatible.



WESTERN STAR: Part #10002841 (FKSTAR2B)

- 4900SA 2012-2016*
- 4900SF 2012-2016*
- 4900XD 2012-2016*
- 4900FA 2012-2016*
- 4900SB 2012-2016*

* 2016 trucks with throttle pedal mounted to the fire wall are not compatible.



WESTERN STAR: Part #10002853 (FKSTAR3B)

- 4900SA 1998-2011
- 4900SF 1998-2011
- 4900FA 1998-2011
- 4900SB 1998-2011



WESTERN STAR: Part #10002863 (FKSTAR4B)

- 4700 equipped with the Cummins Engine and driver side electrical tray 2012-2016*

* 2016 trucks with throttle pedal mounted to the fire wall are not compatible.



WESTERN STAR: Part #10002872 (FKSTAR5B)

- 4700 equipped with the DD13 Engine and driver side electrical tray 2012-2016*

* 2016 trucks with throttle pedal mounted to the fire wall are not compatible.

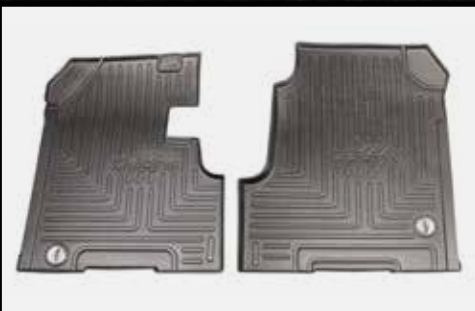

WESTERN STAR: Part #10002882 (FKSTAR6B)

- 4700 Equipped with the DD13 Engine and NO driver side electrical tray 2012-2016*

* 2016 trucks with throttle pedal mounted to the fire wall are not compatible.

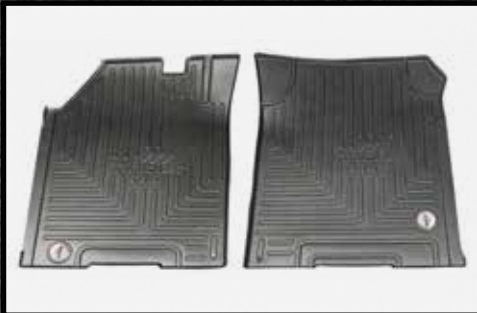

WESTERN STAR: Part #10002890 (103082)

- 4900EX 2016-2020

2020 models with build dates 8/2019 or after are not compatible.

*Floor mats listed above are only compatible with trucks that have the throttle pedal mechanism mounted to the fire wall. Select 2016 models or may be equipped with a floor mounted throttle pedal.

**Includes Glider Kits



WESTERN STAR: Part #10002898 (103083)

- 4700SB & 4700SF (Cummins engine, driver side electric tray) 2016-2020

2020 models with build dates 8/2019 or after are not compatible.

*Floor mats listed above are only compatible with trucks that have the throttle pedal mechanism mounted to the fire wall. Select 2016 models or may be equipped with a floor mounted throttle pedal.



WESTERN STAR: Part #10002908 (103084)

- 5700XE 2016-2020
- 4700SB, 4700SF (Cummins engine, NO driver side electric tray) 2016-2020
- 4900SB, 4900SF, 4900FA 2016-2020**

2020 models with build dates 8/2019 or after are not compatible.

*Floor mats listed above are only compatible with trucks that have the throttle pedal mechanism mounted to the fire wall. Select 2016 models or may be equipped with a floor mounted throttle pedal.

**Includes Glider Kits



WESTERN STAR: Part #10002816 (103085)

- 4700SB, 4700SF (DD13 engine and driver side electrical tray) 2016-2020

2020 models with build dates 8/2019 or after are not compatible.

*Floor mats listed above are only compatible with trucks that have the throttle pedal mechanism mounted to the fire wall. Select 2016 models or may be equipped with a floor mounted throttle pedal.

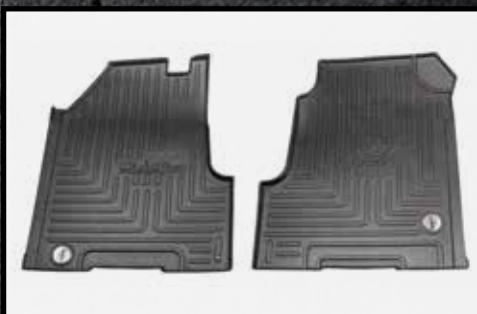

WESTERN STAR: Part #10002827 (103086)

- 4700SB, 4700SF, 4700SF (DD13 engine, NO driver side electric tray) 2016-2020
- 4800SB, 4800SF, 4800TS 2016-2020

2020 models with build dates 8/2019 or after are not compatible.

*Floor mats listed above are only compatible with trucks that have the throttle pedal mechanism mounted to the fire wall. Select 2016 models or may be equipped with a floor mounted throttle pedal.



WESTERN STAR: Part #10005424

- 4700SB, 4700SF (DD13 engine and driver side electrical tray) 2020 - 2022

2020 models with build dates prior to 9/2019 are not compatible.



WESTERN STAR: Part #10005425

- 4700SB, 4700SF, 4700SF (DD13 engine, NO driver side electric tray) 2020-2022
- 4800SB, 4800SF, 4800TS 2020-2022

2020 models with build dates prior to 9/2019 are not compatible.



WESTERN STAR: Part #10005426

- 4700SB & 4700SF (Cummins engine, driver side electric tray) 2020-2022

2020 models with build dates prior to 9/2019 are not compatible.



WESTERN STAR: Part #10005427

- 5700XE 2020-2022
- 4700SB, 4700SF (Cummins engine, NO driver side electric tray) 2020-2022
- 4900SB, 4900SF, 4900FA 2020-2022

2020 models with build dates prior to 9/2019 are not compatible.

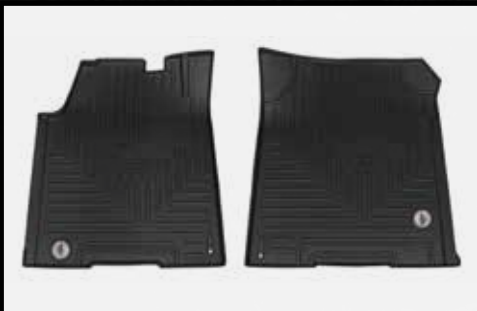

WESTERN STAR: Part #10005428

- 4900EX 2020-2022

2020 models with build dates prior to 9/2019 are not compatible.

A DIVISION OF **HIGH BAR BRANDS, LLC**



**HIGH BAR
BRANDS**



2701 18th Street SW, Owatonna, MN 55060

1-800-248-3855 | Fax: 507-583-7540

www.minimizer.com